



OCEANHDX

Scientific-Grade Spectrometer

Installation and Operation Manual



For Products: OCEANHDX-UV-VIS, OCEANHDX-VIS-NIR, OCEANHDX-XR

Locations

Americas

Ocean Insight, Inc.

8060 Bryan Dairy Rd., Largo, FL 33777, USA

Manufacturing & Logistics

4301 Metric Dr., Winter Park, FL 32792, USA

Sales: info@oceaninsight.com

Orders: orders@oceaninsight.com

Support: techsupport@oceaninsight.com

Phone: +1 727.733.2447

Fax: +1 727.733.3962

Europe, Middle East & Africa

Sales & Support

Geograaf 24, 6921 EW Duiven, The Netherlands

Manufacturing & Logistics

Maybaachstrasse 11, 73760 Ostfildern, Germany

Email: info@oceaninsight.eu

Netherlands: +31 26-319-0500

Netherlands Fax: +31 26-319-0505

Germany: +49 711-341696-0

UK: +44 1865-819922

France: +33 442-386-588

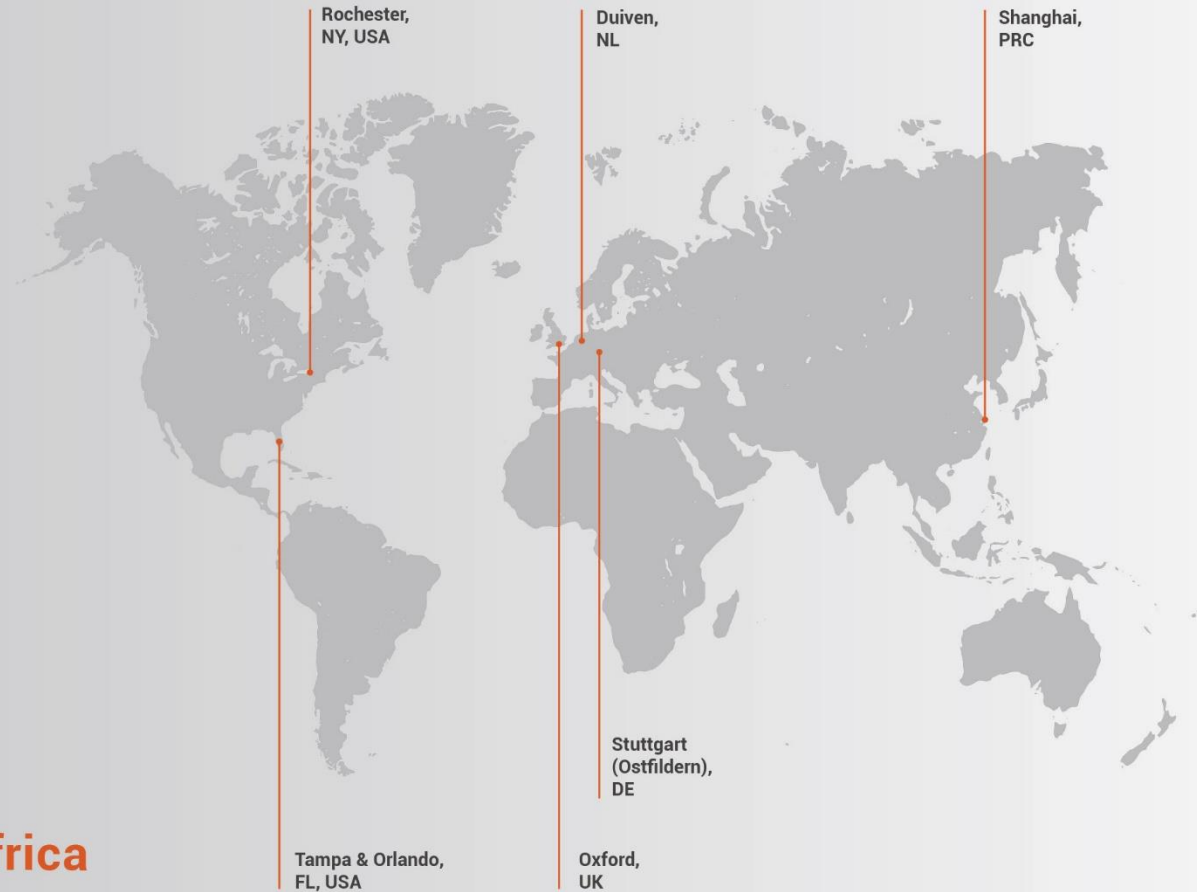

Asia

Ocean Insight Asia

666 Gubei Rd., Kirin Tower Suite 601B
Changning District, Shanghai, PRC, 200336

Email: asiasales@oceaninsight.com

China: +86 21-6295-6600

China Fax: +86 21-6295-6708

Japan & Korea: +82 10-8514-3797

www.oceaninsight.com

Table of Contents

About This Manual	i	Items Included with Shipment.....	7
Warnings & Cautions	i	Ocean HDX Installation.....	7
Certifications and Compliance	iii	Troubleshooting	39
Warranty	v	Frequently Asked Questions	39
Introduction	1	Product Upgrades, Repairs and Servicing	42
Product Introduction.....	1	Technical Specifications	45
How the Ocean HDX Spectrometer Works	3	Mechanical Diagram	45
Installation and Setup	7	Performance Specifications.....	46
		Connections and Communications	49

Copyright © 2020 Ocean Insight

All rights reserved. No part of this publication may be reproduced, stored in a retrieval system, or transmitted, by any means, electronic, mechanical, photocopying, recording, or otherwise, without written permission from Ocean Insight.

This manual is sold as part of an order and subject to the condition that it shall not, by way of trade or otherwise, be lent, re-sold, hired out or otherwise circulated without the prior consent of Ocean Insight, Inc. in any form of binding or cover other than that in which it is published.

Trademarks

All products and services herein are the trademarks, service marks, registered trademarks or registered service marks of their respective owners.

Limit of Liability

Every effort has been made to make this manual as complete and as accurate as possible, but no warranty or fitness is implied. The information provided is on an “as is” basis. Ocean Insight shall have neither liability nor responsibility to any person or entity with respect to any loss or damages arising from the information contained in this.

About This Manual

Warnings & Cautions



This device may cause radio interference or may disrupt the operation of nearby equipment. It may be necessary to take mitigation measures such as re-orienting, relocating or shielding the location.

Cautions

Caution: Do not let contaminants get into the bench. Keep the protective cap on the slit aperture when not connected to an accessory, probe or fiber.

Caution: Only change the slit aperture in a clean environment where contaminants including dust cannot enter the bench during the procedure.

Caution: Substitution of a component or accessory different from that supplied may result in measurement error, equipment damage, increased emissions or decreased immunity.

Caution: Repairs should be undertaken only by personnel trained or authorized by Ocean Insight. The device does not contain any user serviceable parts.

Caution: Do not immerse the device in any fluid, place fluids on top of or attempt to clean with liquid detergents or cleaning agents. This may cause an electrical hazard. Do not use if accidental wetting occurs.

- Caution:** Do not remove any covers. Doing so may increase the risk of electrical shock or compromise the integrity of the optical components.
- Caution:** Do not gas sterilize or autoclave this device.
- Caution:** Consult local codes and ordinances for proper disposal of equipment and other consumable goods.
- Caution:** The device and/or accessories may not operate correctly if used or stored outside the relevant temperature and humidity ranges described in the Technical Specifications.
- Caution:** Do not use if device is dropped and/or damaged. Have an authorized service representative check the device before using again.
- Caution:** Be sure to install any software BEFORE connecting the spectrometer to your PC or host system. The software installs the drivers required for spectrometer installation. If you do not install the software first, the system may not properly recognize the spectrometer.
- Caution:** To ensure reliable operation, it is recommended that the power supply be attached prior to inserting the USB connector.
- Caution:** The user of this spectrometer shall have the sole responsibility for any malfunction which results from improper use, faulty maintenance, improper repair, damage or alteration by anyone other than Ocean Insight or their authorized service personnel.

Certifications and Compliance



This is an FCC Class A product. In a domestic environment, this product may cause radio interference in which case the user may be required to take adequate measures.



FCC Compliance

This equipment has been tested and found to comply with the limits for a Class A digital device, pursuant to Part 15 of the FCC Rules. These limits are designed to provide reasonable protection against harmful interference when the equipment is operated in a commercial environment. This equipment generates uses and can radiate radio frequency energy and, if not installed and used in accordance with the instruction manual, may cause harmful interference to radio communications. Operation of this equipment in a residential area is likely to cause harmful interference in which the user will be required to correct the interference at his own expense.

Warning



The authority to operate this equipment is conditioned by the requirement that no modifications will be made to the equipment unless the changes or modifications are expressly approved by the manufacturer.



WEEE Compliance

The WEEE symbol on the product indicates that the product must not be disposed of with normal household waste. Instead, such marked waste equipment must be disposed of by arranging to return to a designated collection point for the recycling of waste electrical and electronic equipment. Separating and recycling this waste equipment at the time of disposal will help to conserve natural resources and ensure that the equipment is recycled in a manner that protects human health and the environment.



TUV CERTIFICATION

This device has been tested and complies with the following standards:

CAN ICES-003, Class A

CISPR 11:2009.A1:2010

EN 61326-1:2013



EMC 2014/30/EU

RoHS-compliant

ISO Certification

Ocean Insight, the industry leader in miniature photonics, has been certified for ISO 9001:2015 certification applicable to the design and manufacture of electro-optical equipment.

Warranty

For the most current warranty information, please visit OceanInsight.com.

Introduction

Product Introduction

The Ocean HDX is a miniature modular spectrometer with enhanced connectivity and onboard processing that is based upon a crossed Czerny-Turner design. Ocean HDX is built using manufacturing techniques that help deliver high thermal stability and low unit to unit variation without compromising the flexibility and configurability that are the hallmark of the design. Features such as interchangeable slits, indicator lights and simpler device connectors deliver more freedom and less frustration. In addition, Ocean HDX utilizes a host of communication options including USB 2.0, Gigabit Ethernet, RS232, 802.11a/b/g/n WiFi and Access Point WiFi.

Product Features

High Definition Optics	Large bench optical performance in a small bench. Superior resolution and low stray light.
Very High Thermal Stability	Allows for accurate and repeatable measurements in demanding environments and applications.
Sensitive	Responsive from 200 – 1100 nm with great sensitivity in the UV.
Large Onboard Memory	Onboard buffering stores up to 50,000 time-stamped spectra so you will not miss a single data point.
Onboard Averaging	Increase signal-to-noise by averaging onboard and reduce transfer times.
Expanded Connectivity	Gigabit Ethernet, WiFi, Access Point WiFi, USB and RS-232 for easy integration into almost any system as well as 8 GPIO for connection to external devices.
On-the-fly Slit Modifications	User-interchangeable slit allows quick changes to resolution and throughput allowing one spectrometer to perform multiple types of experiments such as absorbance and fluorescence.
Portable Robust Design	Compact, rugged and lightweight for use in the lab or in remote applications.

Product Versions

Several variants of the Ocean HDX Spectrometer exist. Ocean Insight offers both preconfigured units as well as custom-configured units, enabling you to order a customized spectrometer optimized for your application. You can determine spectrometer details, such as spectral range and slit size, by looking at the product code located on the bottom of your spectrometer.

OCEAN HDX Preconfigured Models			
	Model	Range (nm)	Slit (μm)
General Purpose	OCEAN HDX-UV-VIS	200-800	10
	OCEAN HDX-VIS-NIR	350-925	10
Extended Range	OCEAN HDX-XR	200-1100	10

How the Ocean HDX Spectrometer Works

This section provides an overview of the Ocean HDX spectrometer and how it works from light entering the slit to the communication of the spectrum to a connected device. It also provides an overview of all the different possible configurations that are possible, designed to help you optimize your spectrometer for specific applications.

You'll find more useful information, including a glossary of spectroscopy and spectrometer terms, on our website at OceanInsight.com.

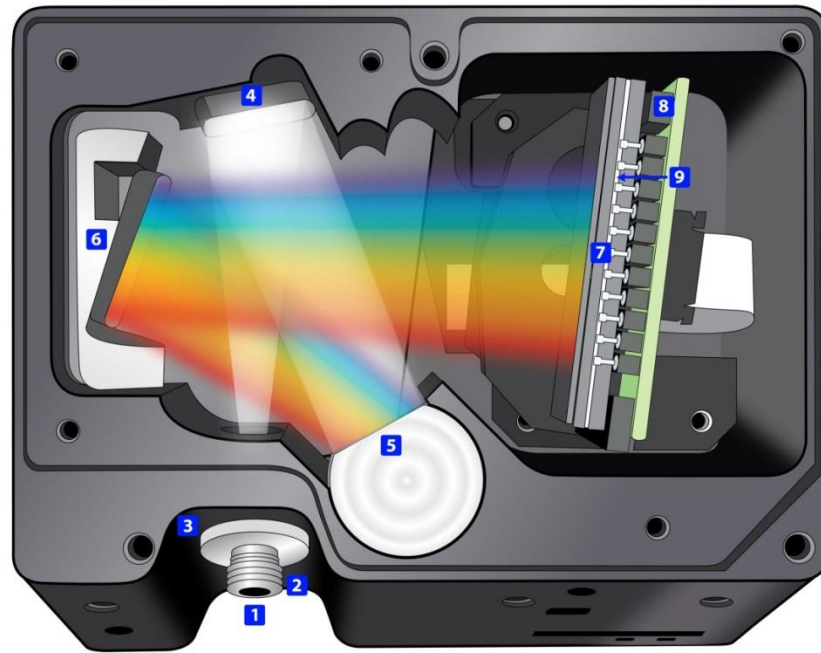

Ocean HDX Open Bench

1. **Fiber Optic Connector:** Light from a fiber enters the optical bench through the SMA 905 Connector. The SMA 905 bulkhead provides a precise location for the end of the optical fiber, slit, absorbing filter and fiber clad mode aperture. While we supply SMA connectors as standard, FC connectors are also available. See #2 for available options.



2. **Interchangeable Slit:** Light passes through the installed slit, which acts as the entrance aperture. Slits come in various widths from 10 μm to 200 μm and the slit is fixed in the SMA 905 bulkhead to sit against the end of a fiber. Smaller slit sizes achieve the best optical resolution while larger slits have higher light throughput. Slit size is labeled on the aperture as shown in the photo.



Slit	Description
INTSMA-10	10-μm wide x 1-mm high
INTSMA-25	25-μm wide x 1-mm high
INTSMA-50	50-μm wide x 1-mm high
INTSMA-100	100-μm wide x 1-mm high
INTSMA-200	200-μm wide x 1-mm high
INTSMA-000	Interchangeable bulkhead with no slit
INTSMA-KIT	Interchangeable SMA Kit connectors; 10μm; 25μm; 50μm; 100μm and 200μm

Ocean Insight also offers a range of FC connector slits in the same wavelengths, with the product code INTFC-XXX. An INTFC-KIT is also available. Note that these items are made to order and have a longer lead time. Contact an Ocean Insight Application Sales Engineer for more details.

3. **Absorbing Filter (optional):** If selected, an absorbing filter is installed between the slit and the aperture in the SMA 905 bulkhead. The filter is used to limit bandwidth of light entering spectrometer or to balance color. Filters are installed permanently. A filter is for a specific slit. If you anticipate needing the filter with multiple slit sizes, then you must specify

this at the time you order. You will know which filter is installed in each slit because of the color-coded dots on the outside as shown in the figure and described in the table below.

Item Code	Description	Dot 1	Dot 2
OF1-BG28	Bandpass filter, transmits >325 and <500 nm	blue	red
OF1-WG305	Longpass filter; transmits light >305 nm	black	white
OF1-U325C	Bandpass filter, transmits >245 and <390 nm	white	green
OF1-GG375	Longpass filter; transmits light >375 nm	red	black
OF1-GG395	Longpass filter; transmits light >395 nm	white	red
OF1-CGA420	Longpass filter; transmits light >420 nm	orange	white
OF1-GG475	Longpass filter; transmits light >475 nm	green	green
OF1-OG515	Longpass filter; transmits light >515 nm	pink	yellow
OF1-OG550	Longpass filter; transmits light >550 nm	orange	orange
OF1-OG590	Longpass filter; transmits light >590 nm	red	pink
OF1-RG695	Longpass filter; transmits light >695 nm	white	blue
OF1-RG830	Longpass filter; transmits light >830 nm	black	blue
OF1-CGA1000	Nonfluorescing longpass filter, transmits >1000 nm	red	green
OF1-CGA760	Nonfluorescing longpass filter, transmits >760 nm	blue	black
OF1-CGA780	Nonfluorescing longpass filter, transmits >780 nm	white	yellow
OF1-CGA830	Nonfluorescing longpass filter, transmits >830 nm	green	orange
OF1-CGA475	Nonfluorescing longpass filter, transmits >475 nm	yellow	pink

4. **Collimating Mirror:** Light reflects from the collimating mirror as a collimated beam toward the grating.

5. **Grating:** In optics, a diffraction grating is an optical component with a periodic structure that splits and diffracts light into several beams traveling in different directions. The directions of these beams depend on the spacing of the grating and (most importantly for spectroscopy) the wavelength of the light. In a spectrometer, the grating acts as the dispersive element. Most spectrometers make use of a grating to split the incoming beam of light into its component wavelengths. This makes use of the optical principle of diffraction; that different wavelengths will be transmitted or reflected from a dispersive element through varying angles, thereby separating one multi-wavelength beam into many single-wavelength beams. Typically, a balance must be struck between these two parameters: as you increase the number of lines/mm on a grating, you increase resolution but decrease the wavelength range that may be scattered.



6. **Focusing Mirror:** This mirror focuses first-order spectra on the detector plane.

7. **Detector:** Ocean HDX utilizes a back-thinned CCD array detector.

8. **Detector Window:** The detector includes a clear, quartz window that often includes an order-sorting filter designed to block second and third order diffraction effects. Light reflected off the grating can propagate these 2nd and 3rd order effects at whole multiples of the incident light. Order-sorting filters reject this stray light only allowing the desired wavelength through to the detector.

Installation and Setup

Items Included with Shipment

- Ocean HDX Spectrometer
- Universal Power Supply
- USB Cable
- Ethernet Cable
- Wavelength Calibration Data Sheet (Save this sheet for your records)

Ocean HDX Installation

Software Installation

NOTE

Be sure to install the software BEFORE connecting the spectrometer to your PC. The software installs the drivers required for spectrometer installation. If you do not install the software first, the system will not properly recognize the spectrometer.

If you have already connected the Ocean HDX to a computer running on a Windows platform prior to installing the operating software, consult the Troubleshooting section for information on correcting a corrupt Ocean HDX installation.

Be sure that you download the correct software package for your computer version (32 or 64-bit). See the Frequently Asked Questions in Troubleshooting section for more information on determining your computer version.

Use OceanView version 1.6.7 and above for Ocean HDX. You can use OceanView on the following operating systems.

Software OS	Windows				Apple	Linux
	7	8	8.1	10		
OceanView	✓	✓	✓	✓	OS X Version 10.5 or later on Intel processor	Any version released for an x86 or amd64 platform since 2010

About Ocean Insight Software

OceanView is the general purpose spectroscopy software for all Ocean Insight spectrometers. It is a completely modular, Java-based spectroscopy software platform that operates on Windows, Macintosh and Linux operating systems. The software can control any Ocean Insight spectrometer and device.

OceanView is a user-customizable, advanced acquisition and display program that provides a real-time interface to a variety of signal-processing functions. With OceanView, you can perform spectroscopic measurements (such as absorbance, reflectance, and emission), control all system parameters, collect and display data in real time, and perform reference monitoring and time acquisition experiments. Consult the OceanView manual for hardware requirements when using OceanView.

Initial Configuration

There are 4 options for accessing the Ocean HDX Spectrometer from your computer:

- USB port for a local connection (located on the back of the unit)
- Ethernet connection to your network (located on the back of the unit)
- WiFi connection to your wireless network
- Access Point (AP) WiFi direct wireless connection to a PC or Windows-based tablet (no router or switch needed)

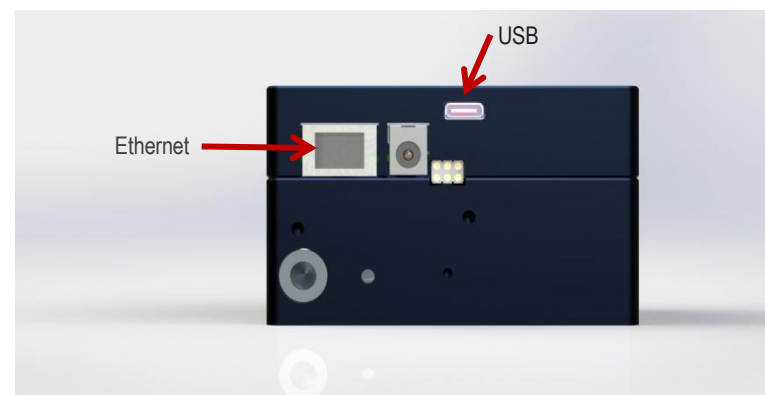

NOTE

BEFORE INITIALIZING ETHERNET OR WIFI, PERFORM USB INITIALIZATION.

If multiple Ocean HDX devices are being used, connection to a particular device may require disconnection and connection activities within the Device Manager of OceanView.

Configuration for USB Connection

NOTE

To ensure reliable operation, it is recommended that the Ocean HDX power supply be connected prior to inserting the USB connector.

To ensure the USB drivers are automatically loaded, the PC should be connected to the internet.

1. Install OceanView software on the destination device prior to connecting the spectrometer.
2. Connect the Ocean HDX power supply to the Ocean HDX and wait for the green indicator light to illuminate.
3. Connect the supplied USB cable to the USB connector on the Ocean HDX and the destination device. Wait for device drivers to install before progressing.
4. Start the OceanView application.



5. If applicable, click “No” for creating a simulation.

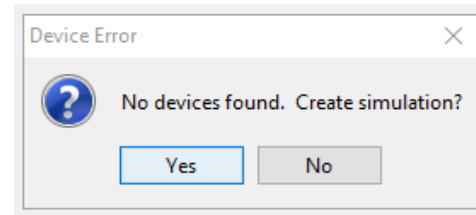

6. The Welcome Screen will be displayed. Click the “OK” button.

7. If the USB connection does not automatically connect, click on the device manager icon.

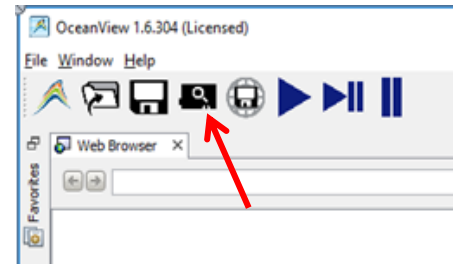

8. Verify that:

- a. “Automatically connect to device” and “Automatically connect to remote device” are checked.
- b. “Simulate device if none found” is not checked as shown.

9. Click the Exit button.

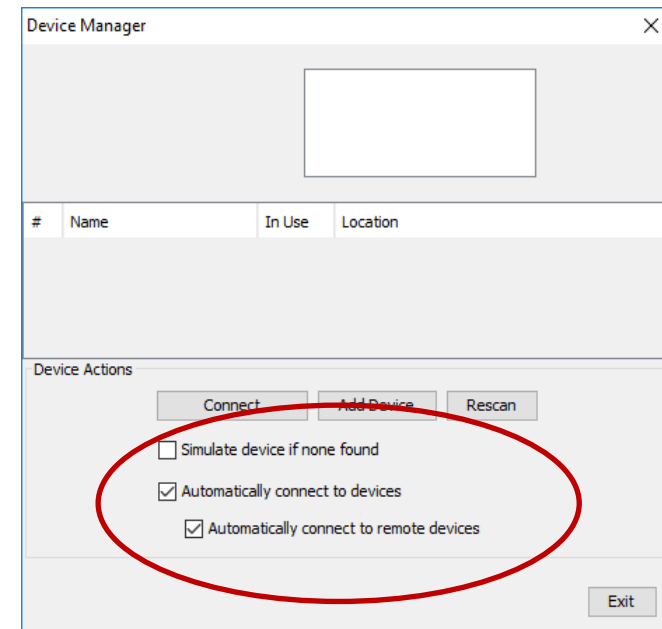

10. Select the OceanView's "Schematic" view if not already the active view. This can be done by clicking Schematic Window on the side bar or by choosing Schematic from the Window tab.

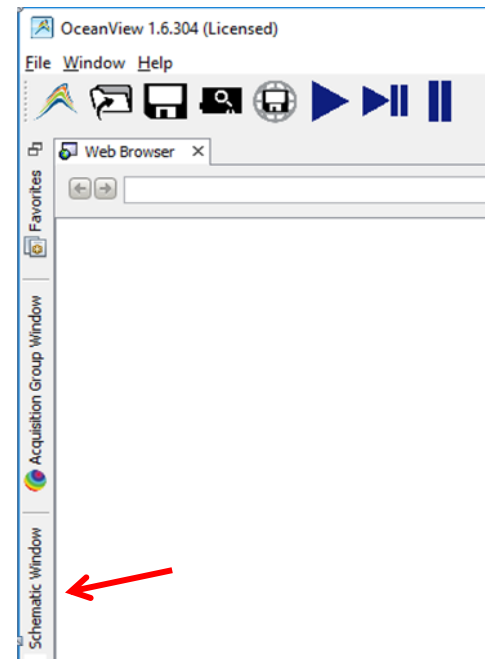

11. The Ocean HDX icon will show up in OceanView's schematic window as shown.

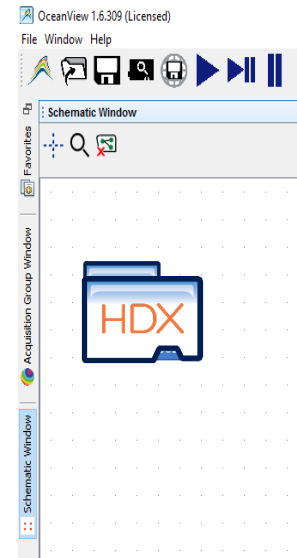

12. If the device does not appear, go back to Device Manager and click the "Rescan" button.

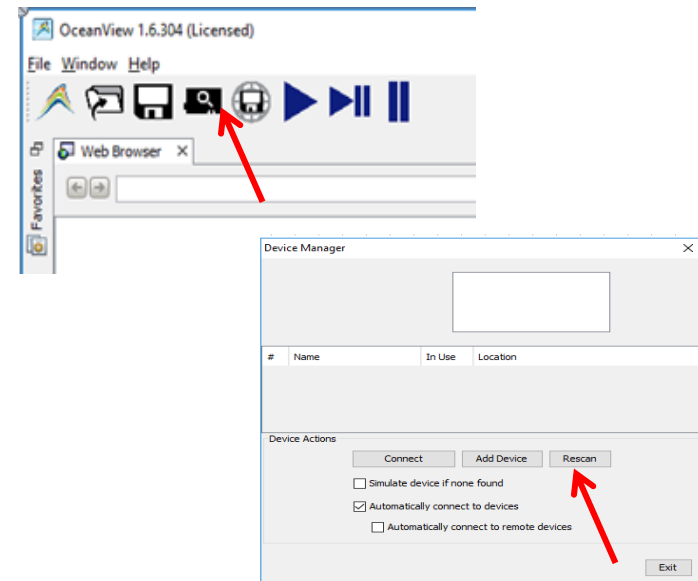

13. Your Ocean HDX device will appear in the Device Manager window and in the schematic view.

14. Continue your setup as described in [Experiment Setup](#) section.

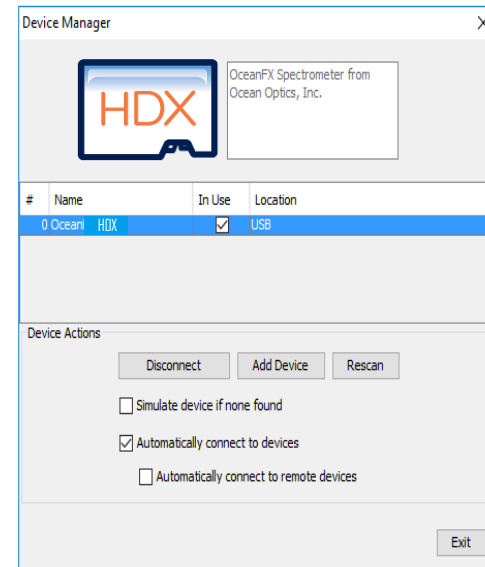

Configuration for Ethernet Connection

NOTE

To ensure reliable operation, it is recommended that the power supply be connected prior to inserting the Ethernet connector. For Ethernet to connect properly, the host computer must be wirelessly connected to the same router as the Ocean HDX Ethernet cable or the Wireless functionality within the host computer must be turned OFF.

1. Connect the Ocean HDX power supply to the Ocean HDX and wait for the green indicator light to illuminate. Wait an additional 90 seconds before moving on to the next step.
2. Connect USB cable provided with the Ocean HDX.

- 3. Start the OceanView application.
- 4. If the Device Error screen appears, go back and perform the USB initialization procedure.

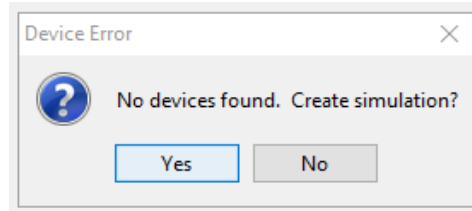

- 5. The Welcome Screen will be displayed. Click the "OK" button.



- 6. Click on the device manager icon.

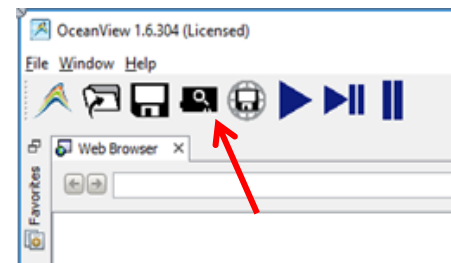

7. Verify that:
 - a. "Automatically connect to device" and "Automatically connect to remote device" are checked.
 - b. "Simulate device if none found" is not checked as shown below.
8. Click the Exit button.

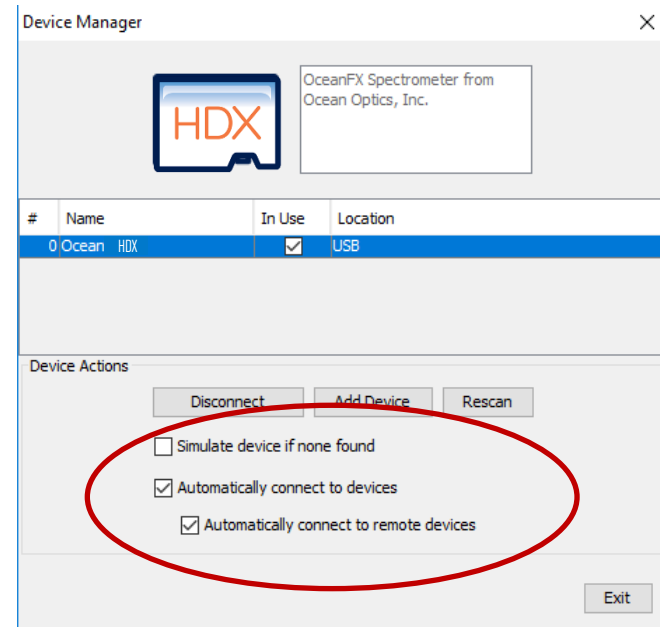

9. Connect the supplied Ethernet cable to the Ethernet connector on the Ocean HDX and to a network router.

10. Select the OceanView's "Schematic" view if not already the active view. This can be done by clicking Schematic Window on the side bar or by choosing Schematic from the Window tab.

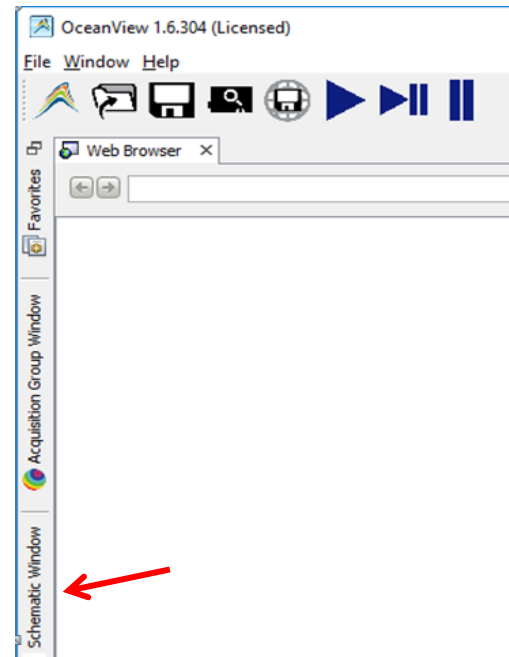

11. The Ocean HDX icon will show up in OceanView's schematic window as shown.

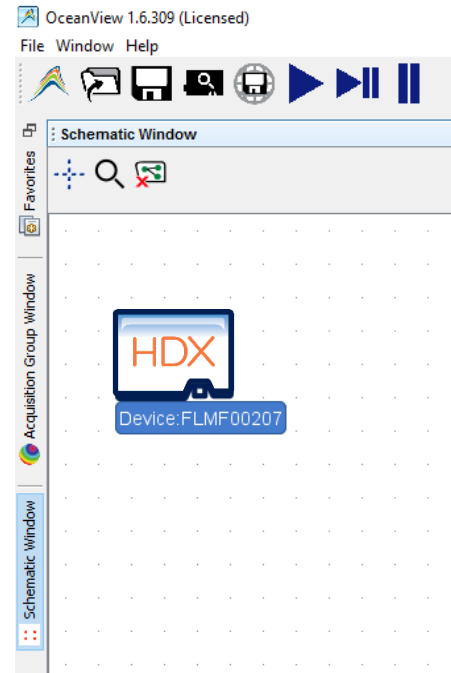

12. In OceanView's schematic mode, right click on the Ocean HDX icon and select "Network Setup" which opens the Network Setup window.

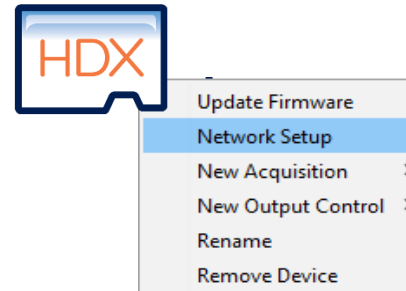

13. Select Interface 0. If necessary, click the “Interface Enable” button. If the Ethernet settings do not appear under Interface 0, then close the window and right click again on the Ocean HDX icon and select “Network Setup”. Ethernet options will appear under Interface 0.

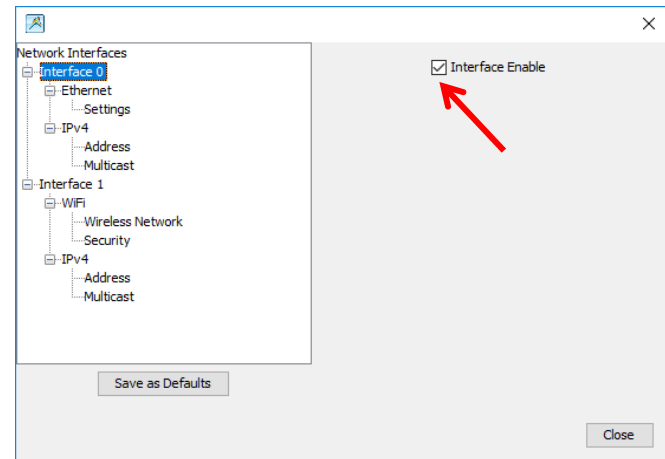

14. Select “Settings” under Ethernet and click “Enable Gigabit Ethernet”.

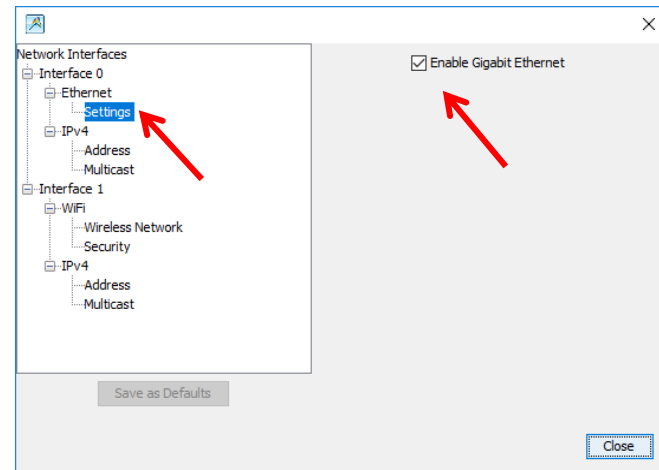

15. Select “Address” under IPv4 and click “Enable DHCP” and then click the Refresh button.

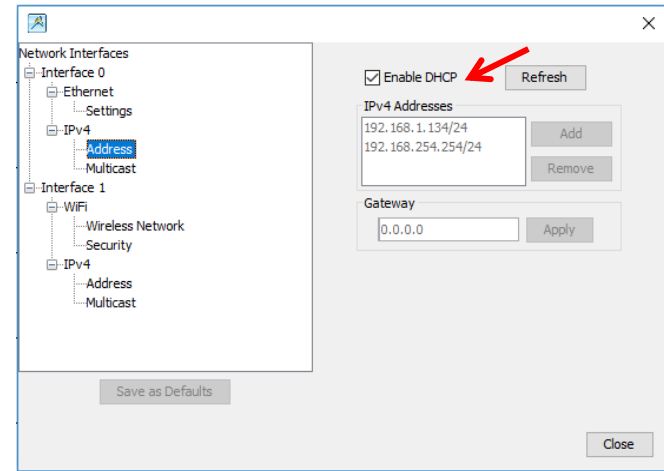

16. Select “Multicast” under IPv4 and click “Enable multicast”.

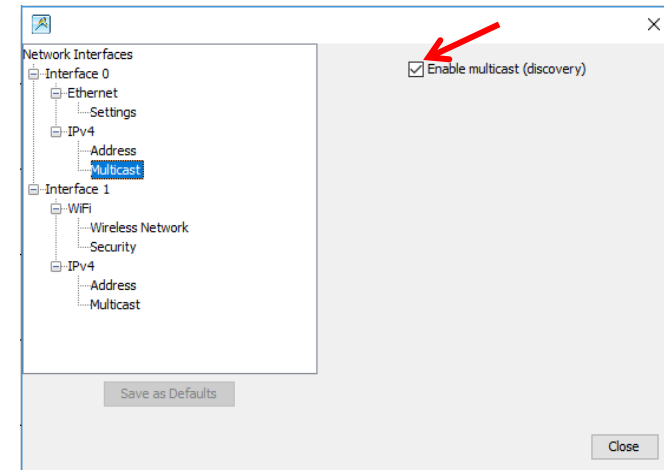

17. Select Interface0. Then click “Save as Defaults” which will upload these settings to the Ocean HDX. Click the Close button.

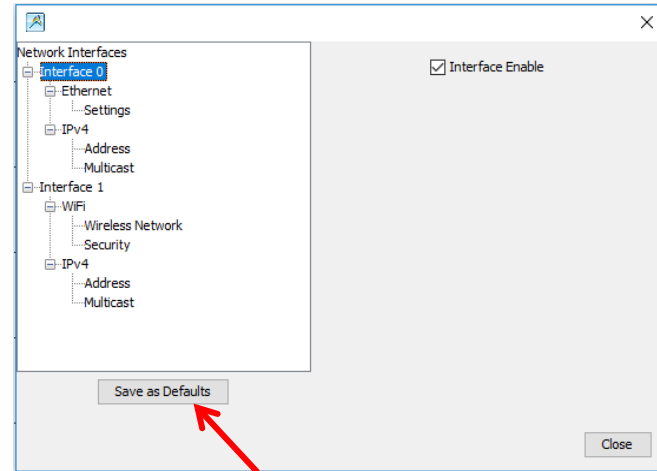

18. Close OceanView and cycle power on the Ocean HDX to enable the new settings. Wait 2 minutes then restart OceanView.

19. Click on the Device Manager icon.

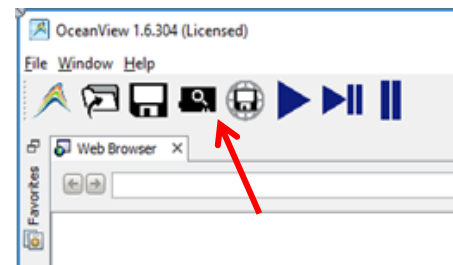

20. In Device Manager, verify that network device has been located. If necessary, click the “Rescan” button to discover the device.

21. Verify the USB device is highlighted. Click on the “Disconnect” button for the USB device and exit Device Manager.

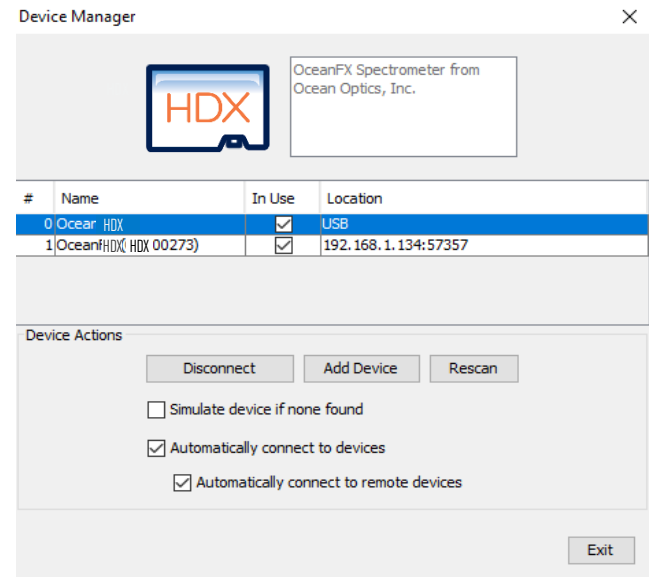

22. Disconnect the USB cable and close and restart OceanView. When restarted, the Ethernet connection will be activated.

23. Continue your setup as described in [Experiment Setup](#) section.

NOTE

For future Ethernet use after configuration, wait 2 minutes after powering up the Ocean HDX before opening OceanView.

Initial configuration must be done via USB prior to attempting a WiFi connection.

The host device with OceanView must be connected to the same WiFi router as the Ocean HDX.

Before attempting WiFi configuration, the Ocean HDX must be powered on for at least 2 minutes.

The Ocean HDX should be within 15 feet of the wireless router.

Configuration for WiFi Connection

1. Connect the Ocean HDX power supply to the Ocean HDX and wait for the green indicator light to illuminate. Wait an additional 90 seconds before moving on to the next step.
2. Connect USB cable provided with the Ocean HDX.
3. Start the OceanView application.
4. If the Device Error screen appears, go back and perform the USB initialization procedure.

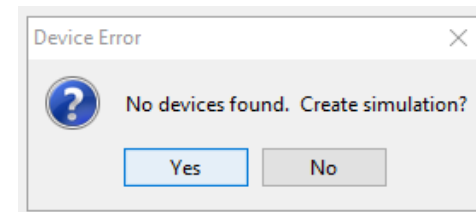

5. The Welcome Screen will be displayed. Click the "OK" button.



6. Click on the Device Manager icon.

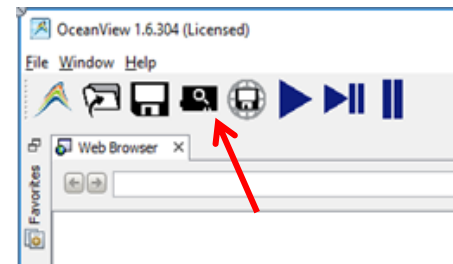

- 7. Verify that:
 - a. "Automatically connect to device" and "Automatically connect to remote device" are checked.
 - b. "Simulate device if none found" is not checked as shown.

- 8. Click the Exit button.

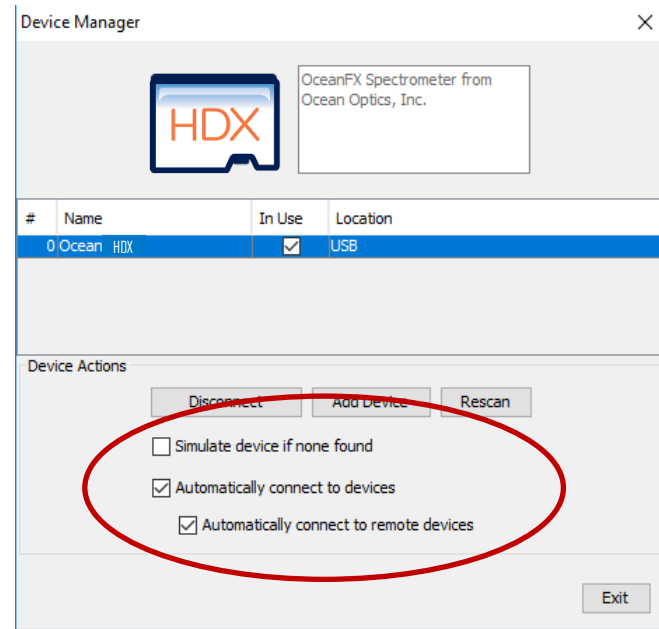

- 9. In OceanView's schematic mode, right click on the Ocean HDX icon and select "Network Setup" which opens the Network Setup window.

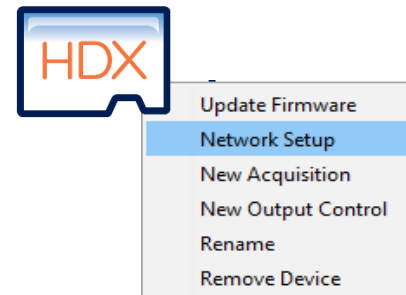

10. Select Interface 1. If necessary, click the “Interface Enable” button. If the WiFi settings do not appear under Interface 1, then close the window and right click again on the Ocean HDX icon and select “Network Setup”. WiFi options will appear under Interface 1.

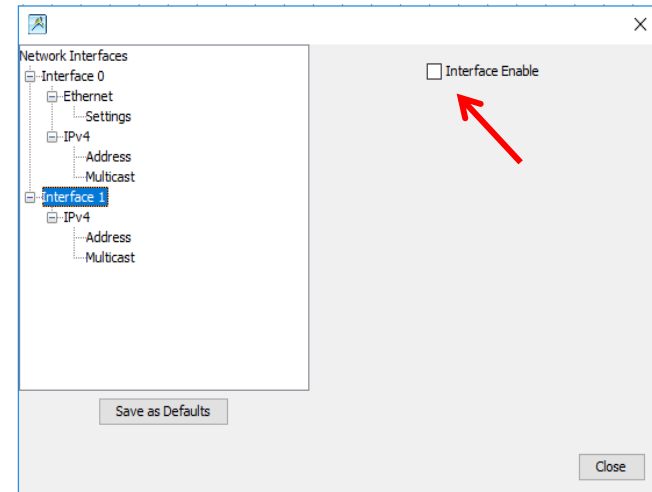

11. Select Security which will show options in the upper right corner of the screen. Select the desired security either Open or WPA2. If WPA2 is selected, enter the password or phrase that corresponds to your wireless router. Click the “Apply” button.

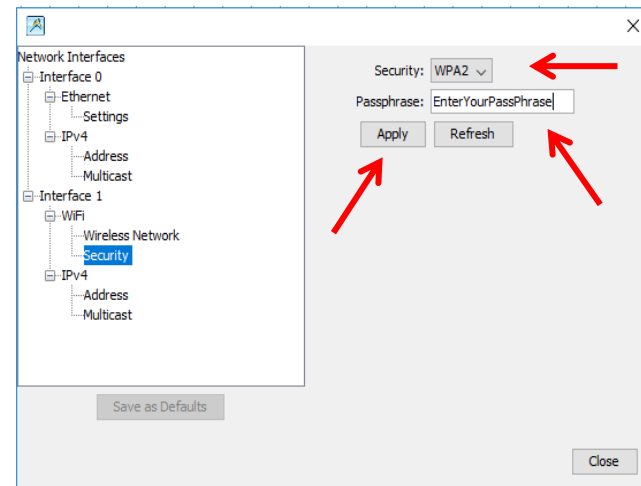

12. Then select Wireless Network under Interface 1. Mode will default to Client. Enter the SSID for the network device and click the “Apply” button.

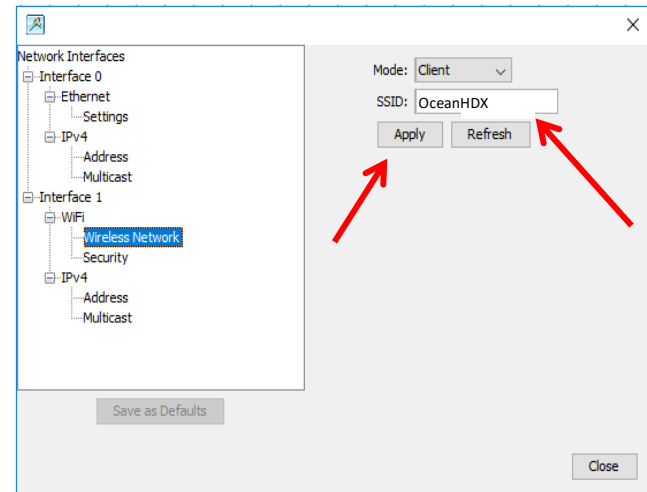

13. Select Address. Verify the “Enable DHCP” box is checked. If not, check the box and click Refresh.

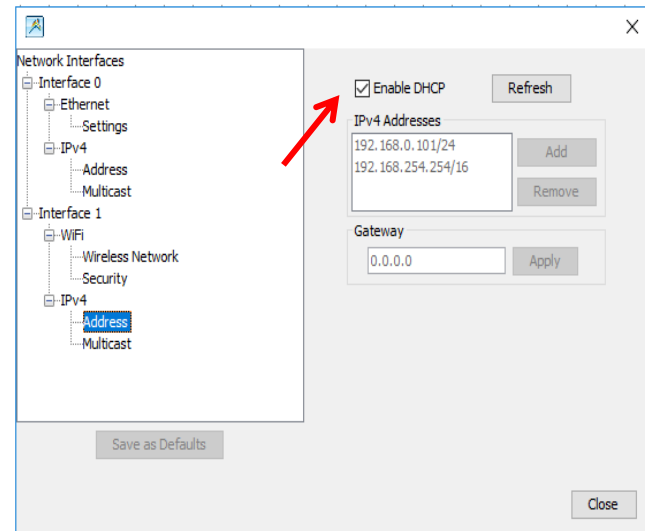

14. Select Multicast. If necessary, click the “Enable Multicast (discovery)” button.

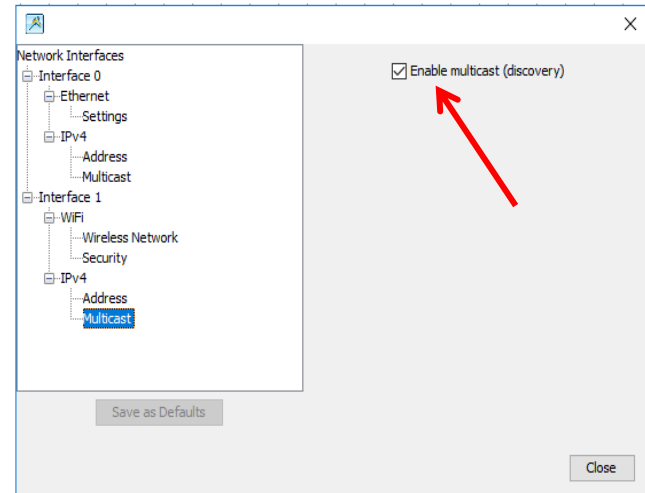

15. Select Interface 1 and then click the “Save as Defaults” button which will upload these settings to the Ocean HDX. Click the Close button.

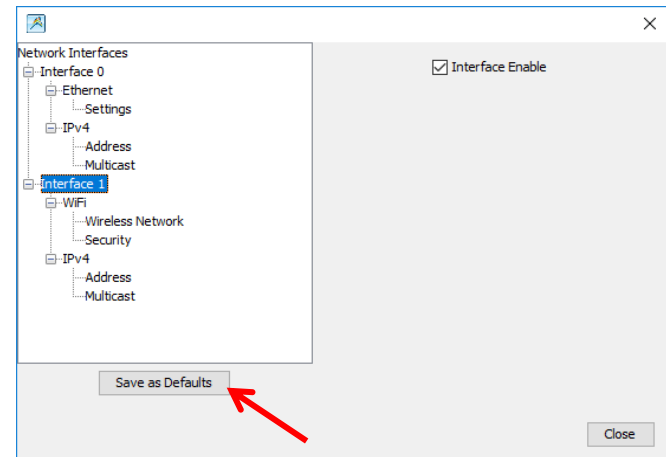

16. Disconnect USB cable from the Ocean HDX.
17. Close OceanView and cycle power on the Ocean HDX to enable the new settings. Wait 2 minutes then restart OceanView.
18. If device does not appear correctly, consult the troubleshooting section.
19. Continue your setup as described in the [Experiment Setup](#) section.

NOTE

When using WiFi after initial configuration, wait 2 minutes after powering up the Ocean HDX before opening OceanView.

Configuration for AP WiFi Connection

Access Point (AP) WiFi is similar to Bluetooth in that it is a point-to-point or device-to-device connection and does not need a router or switch.

NOTE

Initial configuration of the Ocean HDX must be done via USB prior to attempting AP WiFi connection.

No router or switch is needed but the host device will need to wirelessly connect directly to the Ocean HDX.

Before attempting AP WiFi configuration, the Ocean HDX must be powered on for at least 2 minutes.

1. Connect the Ocean HDX power supply to the Ocean HDX and wait for the green indicator light to illuminate. Wait an additional 90 seconds before moving on to the next step.
2. Connect USB cable provided with the Ocean HDX.
3. Start the OceanView application.

4. If the Device Error screen appears, go back and perform the USB initialization procedure.

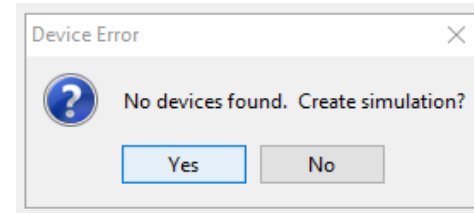

5. The Welcome Screen will be displayed. Click the "OK" button.



6. Click on the Device Manager icon.

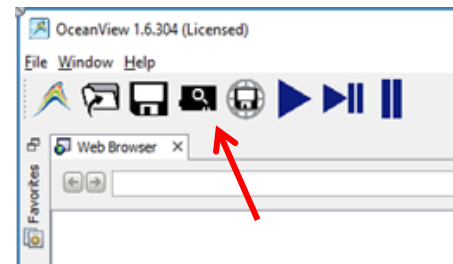

7. Verify that:
- a. “Automatically connect to device” and “Automatically connect to remote device” are checked.
 - b. “Simulate device if none found” is not checked as shown.

8. Click the Exit button.

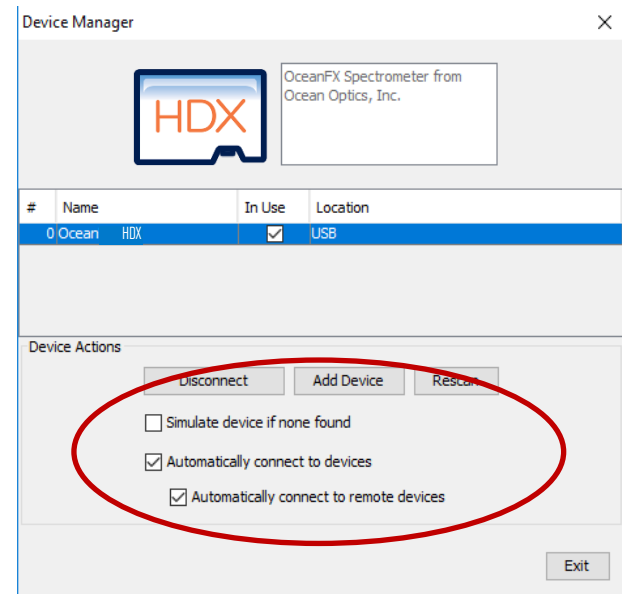

9. In OceanView’s schematic mode, right click on the Ocean HDX icon and select “Network Setup” which opens the Network Setup window.

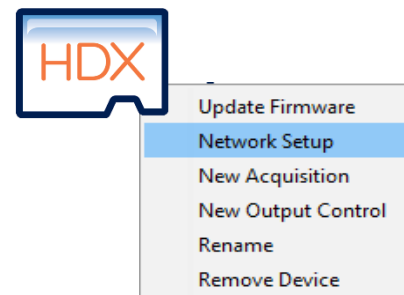

10. Select Interface 1. If necessary, click the “Interface Enable” button. If the WiFi settings do not appear under Interface 1, then close the window and right click again on the Ocean HDX icon and select “Network Setup”. WiFi options will appear under Interface 1.

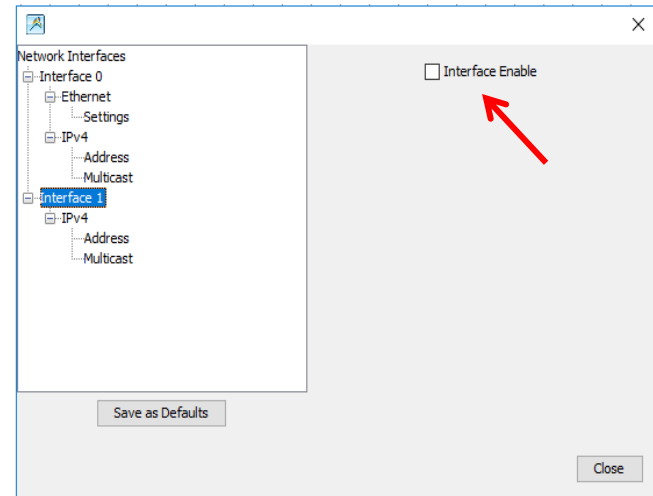

11. Select Security which will show options in the upper right corner of the screen. Select the Open option when using AP WiFi as this is a device-to-device connection. WPA2 security settings can also be used if desired. Click the “Apply” button.

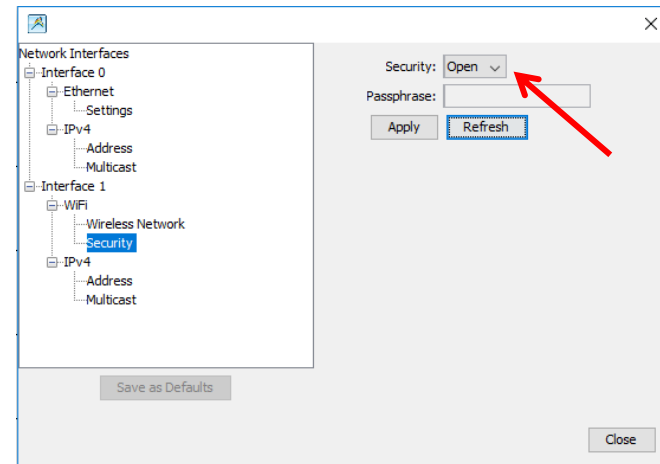

12. Select Wireless Network under Interface 1. Change the mode to Access Point and then click the S/N button which loads the serial number of the connected Ocean HDX. Click the “Apply” button.

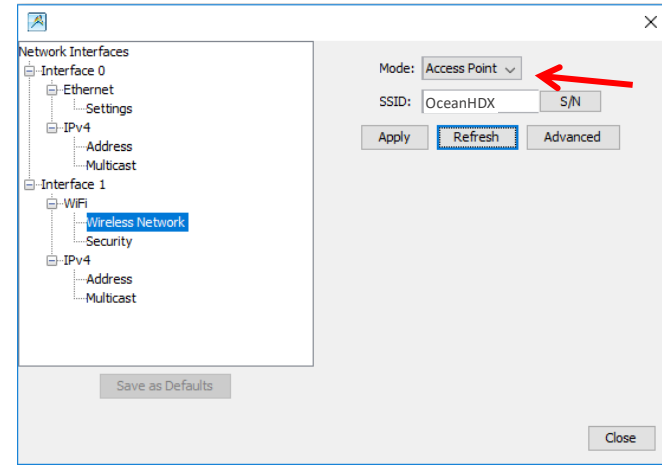

13. Select Address. Verify the “Enable DHCP” box is checked. If not, check the box.

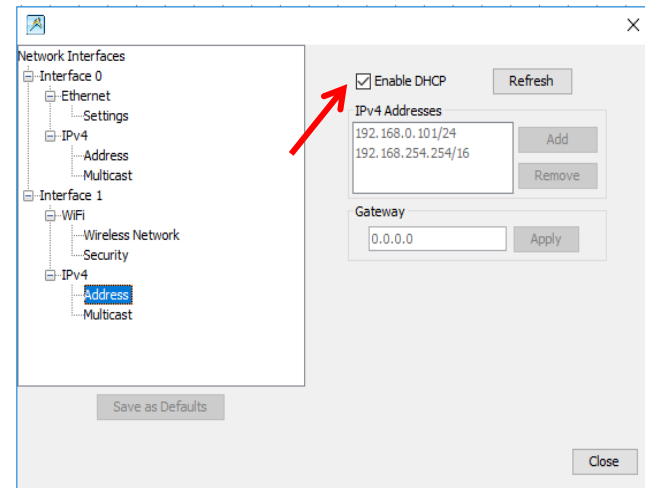

14. Verify that Enable Multicast has been checked. If necessary, click the “Enable Multicast (discovery)” button. Finally, select Interface 1 and then click the “Save as Defaults” button which will save the SSID and passphrase.

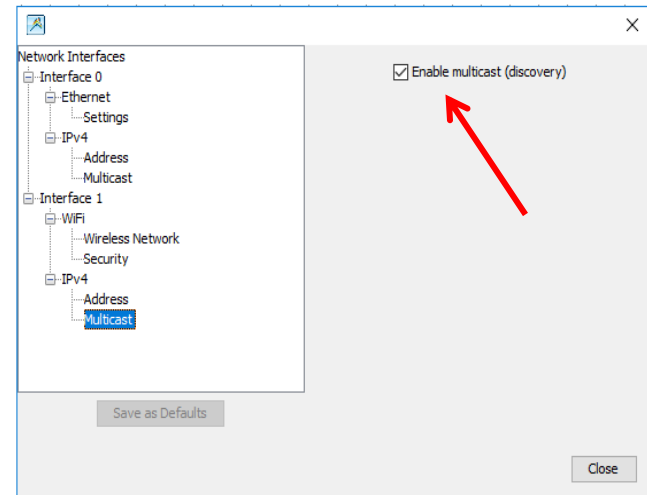

15. Select Interface 1 and then click the “Save as Defaults” button which will upload these settings to the Ocean HDX. Click the Close button.

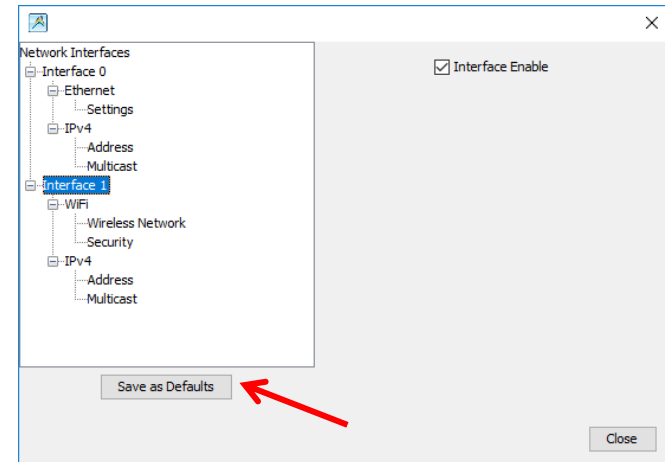

16. Disconnect USB cable from the Ocean HDX.

17. Close OceanView and cycle power on the Ocean HDX to enable the new settings. Wait 2 minutes.

18. In your device's WiFi settings, choose and connect the Ocean HDX WiFi option.

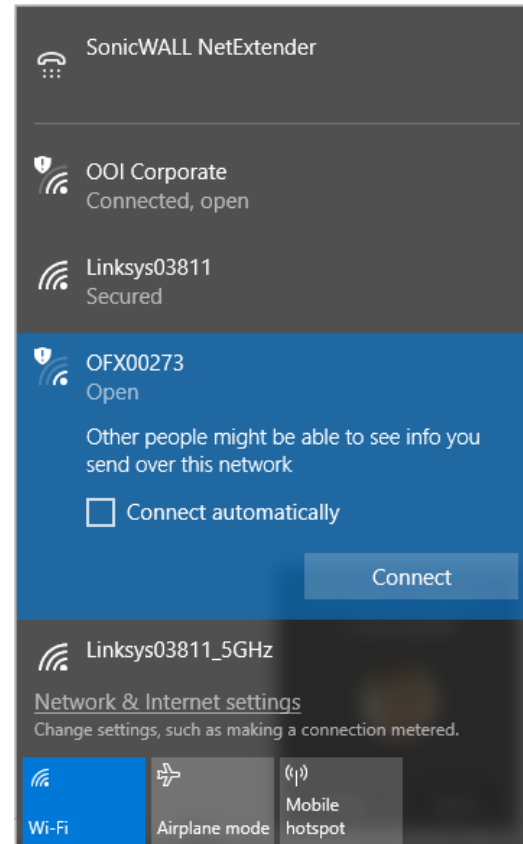

- 19. Open OceanView which will connect wirelessly to the Ocean HDX.
- 20. If device does not appear correctly, consult the troubleshooting section.
- 21. Continue your setup as described in the [Experiment Setup](#) section.

NOTE

When using WiFi after initial configuration, wait 2 minutes after powering up the Ocean HDX before opening OceanView.

Power Sequences

Power ON Sequence

Power up the Ocean HDX prior to opening controlling software such as OceanView. Before starting software, the following wait times are needed for proper connectivity operation:

USB:	No wait time
Ethernet:	Wait 1 minute
WiFi:	Wait 2 minutes

Power OFF Sequence

Close the controlling software before powering down the Ocean HDX.

Experiment Setup

After the Ocean HDX spectrometer is connected in OceanView as described above, you may continue the setup as shown below.

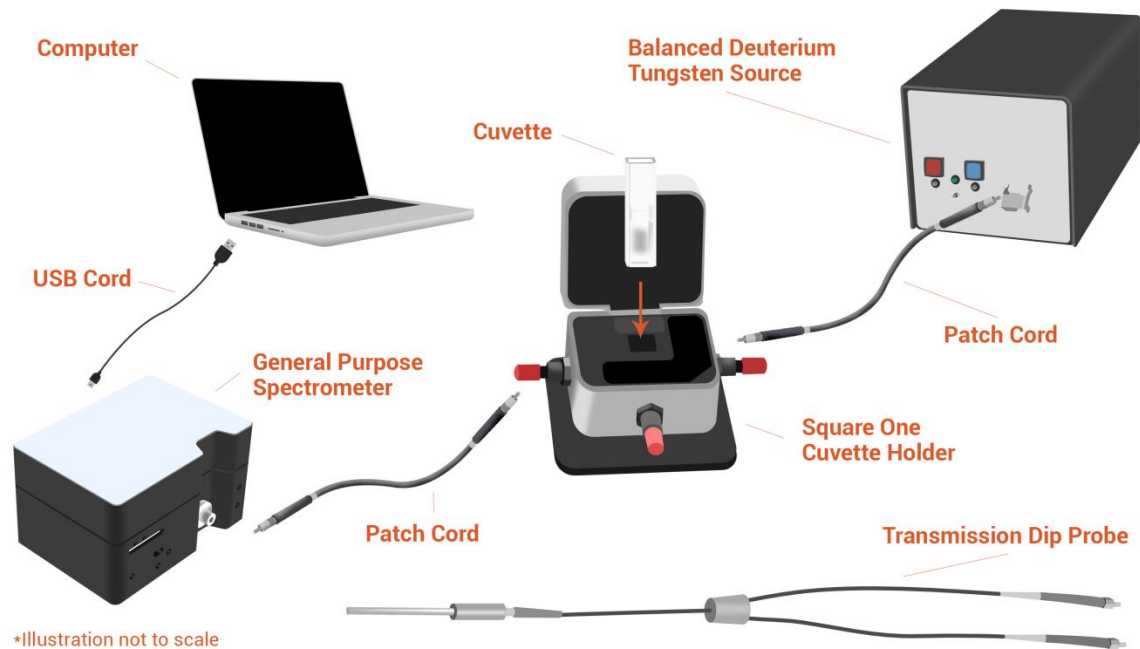

Ocean Insight Ocean HDX Fiber Optic Spectrometer Typical Set-up

1. Connect any spectroscopy accessories. To find operating instructions for Ocean HDX-compatible products (such as light sources, sampling chambers, and probes) go to the Technical Documents section of the Ocean Insight website.
2. Attach the fiber to the fiber optic connector on the spectrometer.

If you installed the spectrometer operating software prior to connecting the Ocean HDX, the software automatically installs the Ocean HDX drivers. If the drivers do not successfully install (or if you connected the Ocean HDX to the computer before installing the software), consult the Troubleshooting section.

NOTE

The Ocean HDX driver may appear as USB2000+ to your computer since a common driver is used to ensure backwards and forwards compatibility. This does not affect functionality.

Ocean HDX Indicator Lights

The Ocean HDX features two indicator lights that operate as shown below:

Light	Steady	Flashing
red	Power is on, unit is booting or in idle state	Unit is acquiring data
green		Heartbeat

Indicator lights can be turned off in OceanView or by using a firmware command.

Interchangeable Slits

The Ocean HDX offers the capability of changing the slit size to match your measurement and application needs. You can order additional replacement slits either individually or as a kit (in various widths). Refer to www.oceaninsight.com for instructions on how to change the slit.

Accessories

Ocean Insight provides a range of standard cables and accessories that connect the Ocean HDX to our large range of sampling and light source accessories utilizing the DD4 connector on the front of the Ocean HDX spectrometer. Items specifically designed for the Ocean HDX are described here; they are not provided with the Ocean HDX spectrometer and must be purchased separately. Visit us at OceanInsight.com for a complete list of products available for all your spectroscopy needs.

Cables and Connectors

Cables are available to connect your Ocean HDX Spectrometer to accessories such as light sources. Cable pinouts and descriptions are located in the Technical Specifications chapter.

Breakout Box (HR4-BREAKOUT)

The Breakout Box is a passive module that separates the signals from the Ocean HDX's DD4 40-pin connector to an array of standard connectors and headers, enabling functionality with a wide range of accessories. In addition to the accessory connector, the breakout box features a circuit board based on a neutral breadboard pattern that allows custom circuitry to be prototyped on the board itself. See the Ocean Insight website for installation and operation instructions.

Troubleshooting

Sometimes things do not go to plan. If not, do not hesitate to contact us and our Tech Support team will leap into action. Some typical questions are answered here. For more information, consult the FAQs on the Ocean Insight website.

Frequently Asked Questions

How do I know my spectrometer has power?

The red LED on the spectrometer should be on steadily if the unit is receiving power.

How do I know my spectrometer is transmitting data?

The red LED on the spectrometer flashes when transmitting data.

How do I check the configuration of my spectrometer?

Check the label on the bottom of your spectrometer. You can also check your configuration using your spectrometer operating software. In OceanView, open the Schematic window and double click the spectrometer icon.

I am installing OceanView but I need a product key. Where can I find this?

The product key was sent to the contact e-mail on the sales order when you purchased your OceanView license. Contact info@oceaninsight.com for more information. You'll need your sales order number, quotation number, the serial number of the spectrometer that was purchased with the software, and, if known, the e-mail address under which your product key was created to recover your key.

How do I determine whether my Windows computer is 32-bit or 64-bit?

Errors can occur if you download the wrong version of software (32-bit or 64-bit). Go to the Properties or Settings window and find system settings.

I connected the USB cable and started OceanView but I do not see my spectrometer attached.

Use the Rescan button in the Device Manager to rescan for attached devices.

I am having trouble installing the drivers. What should I do?

Hardware device driver installation is usually seamless on Microsoft Windows operating systems and should happen in the background when you connect your spectrometer to a computer with the software installed. However, some Windows systems require a bit more care when connecting your spectrometer for the first time.

If your spectrometer is not recognized by OceanView on your computer, you need to manually install the spectrometer drivers. See your OceanView manual for this procedure. Also consult the Correcting Device Driver Issues document on the Ocean Insight website.

I connected the Ocean HDX to the computer before installing my spectroscopy operating software to install the drivers. What do I do now?

The steps to take to resolve this issue differ, depending on your computer's operating system.

Microsoft Windows Operating Systems

NOTE

If these procedures do not correct your device driver problem, you must obtain the Correcting Device Driver Issues document from the Ocean Insight website.

1. Remove the Unknown Device from Windows Device Manager
2. Open Windows Device Manager. Consult the Windows operating instructions if needed.
3. Locate the Universal Serial Bus Devices option and expand the Universal Serial Bus Devices selection by clicking on the "+" sign to the immediate left.

NOTE

Improperly installed USB devices can also appear under the Universal Serial Bus Controller option. Be sure to check this location if you cannot locate the unknown device.

4. Locate the unknown device (marked with a large question mark). Right-click on the Unknown Device listing and select the Uninstall or Remove option.
5. Click the OK button to continue. A warning box appears confirming the removal of the Unknown Device. Click the OK button to confirm the device removal.

Disconnect the Ocean HDX from your computer and then re-connect the spectrometer to your computer. The system should now be able to locate and install the correct drivers for the USB device.

Apple Mac OSX Operating Systems

Since there are no device files for the Ocean HDX Spectrometer in a Mac operating system, you should not encounter any problems if you installed the spectrometer before the spectrometer operating software.

Linux Operating Systems

For Linux operating systems, simply disconnect and then re-connect the USB cable in the spectrometer.

I have both SpectraSuite and OceanView installed. Will my spectrometer work with both?

Ocean HDX only works with OceanView 1.6.7 and later.

I'm attempting to connect via Ethernet but I cannot see the spectrometer. What do I do?

Connect the spectrometer to the computer utilizing the USB cable. Using OceanView, verify the following:

In Network Connections:

- Interface 0 (network) is enabled.
- DHCP is enabled for Interface 0.

In Device Manager:

- See if device is displayed with an Ethernet connection/address. If not, rescan.
- If device is displayed but not connected, click the "connect" button.

I'm attempting to connect via WiFi, but I cannot see the spectrometer. What do I do?

Initial setup must be done using the USB cable. If that has already been done, verify that the computer with OceanView resides on the same network and subnet as the spectrometer.

Connect to the spectrometer utilizing the USB cable. Using OceanView, verify the following:

In Network Connections:

- Interface 1 (WiFi) is enabled.
- DHCP is enabled for Interface 1.
- Security is set up with correct SSID and passphrase.

In Device Manager:

- See if device is displayed with a WiFi connection/address. If not, rescan.
- If device is displayed but not connected, click the “connect” button.

I configured my device via USB and am trying to connect to WiFi. Device manager shows the USB connection and then shows an error message “Error while communicating with the device. Reconnect device and rescan devices.”

Verify the device is properly connected to its power source. In Device Manager, unselect “automatically connect to devices”. Rescan. Once the device is displayed in the window, click “Connect” button. The device will appear. Reselect “Automatically Connect to Devices” option.

Product Upgrades, Repairs and Servicing

Occasionally, you may find that you need Ocean Insight to make a change or an upgrade to your system. To facilitate these changes, you must first contact Customer Support and obtain a Return Merchandise Authorization (RMA) number. Please contact Ocean Insight for specific instructions when returning a product.

Firmware Upgrades

Product enhancements can be accomplished within firmware and the new firmware revisions can be uploaded to the Ocean HDX through OceanView. Below are upgrade instructions.

1. Go to the Ocean Insight website and download the two firmware files from the Software Downloads section. OceanInsight.com/support/software-downloads/
2. Connect your Ocean HDX and open up OceanView (Version 1.6.7 or higher). Do not do this process wirelessly.
3. Go to the Schematic window and right click on the HDX icon and click Update Firmware.

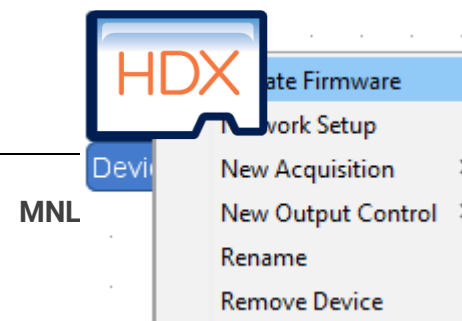

4. In the File Selection box, click the “...” button to locate an OBP file. Choose the larger file.

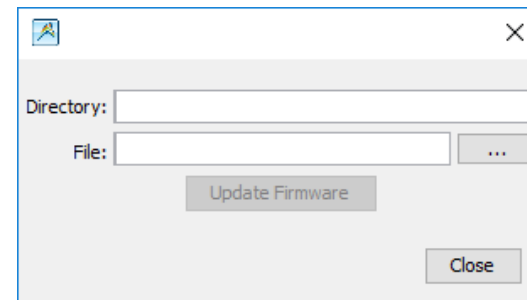

5. Once a file has been selected, click the Upgrade Firmware button.
6. Once complete, OceanView will ask to power-cycle the device. Power cycle the device and also close and restart OceanView.

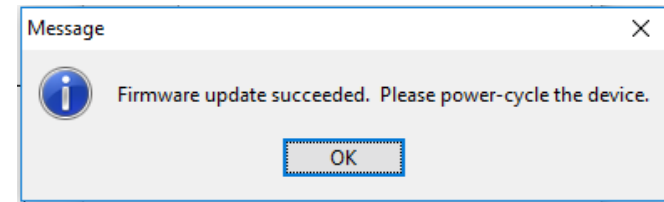

7. Repeat steps 3 through 6 for the second file and then close OceanView, power-cycle the Ocean HDX and re-start OceanView.

Repairs

Sometimes accidents happen! If you need to return your Ocean Insight Product for repair, here is what to do:

1. Contact us to speak to an Ocean Insight representative about the problem. If it is determined that the product must be returned, the representative will issue an RMA number.

2. Package your product, ideally in the original packaging, and return it to Ocean Insight, along with the RMA number that you received.

NOTE

For RMA returns under warranty we will organize and pay for shipping both ways. For accidental damage, you only pay to have the product delivered to your closest Ocean Insight or OOI Distributor Office.

Upon careful examination, we'll advise you with an estimate. When your product is ready, it will be returned to you.

Servicing

To keep your instrument in tip top shape we recommend yearly wavelength recalibration. Contact your local representative to find out more about service availability and cost. We offer the following services:

- Wavelength Calibration
- Absolute Irradiance Calibrations
- Service Plans (Ocean Care and Ocean Care Plus)

Technical Specifications

Mechanical Diagram

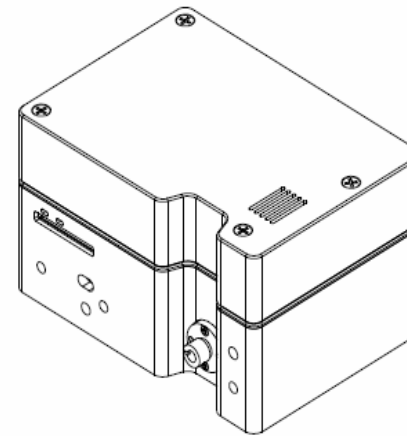
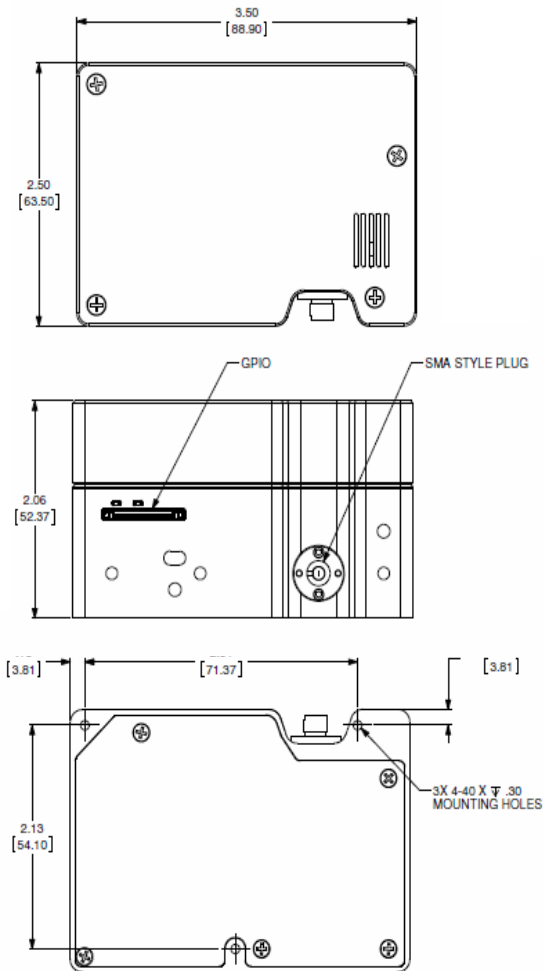

Performance Specifications

Absolute Maximum Ratings	
Input Voltage (Vin, VBatt, GPIO)	0 to +5.5V
Input Voltage (RS232)	+/- 25V
Input Voltage (I2C, SPI, Other I/O)	0 to +3.6V

Performance Specifications	
Storage Temperature	-30°C to +70°C
Storage Humidity	0 to 90% RH non-condensing
Operating Temperature	0°C to +40°C
Operating Humidity	0 to 90% RH non-condensing
Recommended Frequency of Calibration	Optical calibration should be performed annually
Ethernet	Gigabit transfer rate
USB 2.0	Up to 480Mbps data rate
WiFi	802.11 a/b/g/n

Electrical Characteristics					
Parameter	Conditions	MIN	TYP	MAX	UNITS
Input Current <small>(Note 1)</small>	+5.0V, external power supply		0.9	2.5	A
Supply Voltage (V _{in})		4.75	5.0	5.25	V
GPIO Logic Input Low				0.9	V
GPIO Logic Input High		2.4			V
GPIO I _{SOURCE} / I _{SINK}			1.6		mA
GPIO Output Low	I _{SOURCE} = 1 mA			0.4	V
GPIO Output High	I _{SOURCE} = 1 mA	3.1			V
GPIO DAC Resolution			12		Bits
GPIO DAC Output Range		0		5	V
I2C / SPI Logic Level	I2C pullup resistor onboard		3.3		V
RS232 Output High		5.0	5.4		V
RS232 Output Low		-5.0	-5.4		V
Other I/O Voltage Range			3.3		V

Note 1: Maximum input current includes 1.0A for powering accessories through the DD4 connector. If no accessories are powered through this connector, then maximum input current drops to 1.5A.

Optical and Spectroscopic Characteristics				
Parameter	MIN	TYP	MAX	UNITS
Detector Response Range <small>(Note 2)</small>	200		1100	nm
Integration Time	6		10E3	ms
Dynamic Range		12,000		
Signal-to-Noise Ratio		400		
Resolution (FWHM) <small>(Note 3)</small>	0.75		1.2	nm
Stray Light <small>(Note 4)</small>		3.93		A.U.
Buffer Depth (onboard memory)			50000	Spectra
Thermal Stability for entire temperature range		+/- 1.0		Pixels
Trigger Jitter			21	ns

Note 2: Spectral range for each spectrometer will be determined by specific features of the optical components.

Note 3: Average optical resolution of a spectrometer across entire wavelength spectrum, measured as full width at half maximum (FWHM), depends on the groove density of the grating and the diameter of the entrance optics (optical fiber or slit).

Note 4: Stray light is measured using an RG850 and KG3 filter after a tungsten-halogen source.

Mechanical Specifications	
Parameter	Specification
Spectrometer Topology	Asymmetric Crossed Czerny-Turner
Input Fiber Connector	SMA 905 or FC/PC
Entrance Slit	10, 25, 50, 100, or 200 μ m slits. (Slits are optional. In the absence of a slit, the fiber acts as the entrance slit.)
Gratings	Specifications vary by grating choice
Physical Dimensions	88.9 mm x 63.5 mm x 52.4 mm
Weight	0.4 kg (14.1 oz)
Mounting	No restrictions on mounting. Can be mounted at any angle or position.

Connections and Communications

DD4 Accessory Connector

The Ocean HDX features a 40-pin Accessory Connector, located on the front of the unit.

The 40-pin Accessory Connector (Part Number: DD4RA40JA1) that has two mating connectors available: DD4PA40MA1 (right angle) and DD4BA40WA1 (vertical).

Pin 1 is on the right when viewing the 40-pin Accessory Connector from the front of the spectrometer. This connector is used to connect sampling and light sources to the Ocean HDX.

DD4 Accessory Connector Pinout			
Pin#	Signal Name	Voltage Level	Description
1	GND	0	System Ground
2	IO_TRIG_EXT	+3.3	Programmable Hardware Trigger
3	IO_STROBE_CONT_EXT	+3.3	Programmable Continuous Strobe
4	IO_STROBE_SINGL_EXT	+3.3	Programmable Single Strobe
5	LAMP_EN	+3.3	Programmable Discrete Output
6	GPIO_0	+3.3/+5.0	General Purpose Software Programmable Digital Inputs/Output, Analog Output. Digital Outputs are 3.3V. Analog Outputs Can Be Programmed To 2.5V or 5.0V Max.
7	GPIO_1		
8	GPIO_2		
9	GPIO_3		
10	GND		
11	GPIO_4		
12	GPIO_5		
13	GPIO_6		
14	GPIO_7		
15	GND	0	System Ground
16	SPI_SCLK	+3.3	Master Clock. See SPI Below.
17	SPI_MOSI	+3.3	SPI Master Out Slave In (MOSI) is for communication to other SPI peripherals. See SPI below.

18	SPI_CS	+3.3	SPI Chip Select signal. See SPI Below.
19	SPI_MISO	+3.3	SPI Master In Slave Out (MISO) is for communication to other SPI peripherals. See SPI below.
20	GND	0	System Ground
21	I2C4_SCL	+3.3	I2C Master Clock. See I2C below.
22	I2C4_SDA	+3.3	I2C Master Data. See I2C below.
23	GND	0	System Ground
24	RS232_TX	-6 to +6	RS232 Transmit Signal
25	RS232_RX	-25 to +25	RS232 Receive Signal
26	RS232_CTS	-6 to +6	RS232 Clear To Send
27	RS232_RTS	-25 to +25	RS232 Request To Send
28	IO_RESET#	+5.0	Pull Low to reset device
29	IO_PWR_DIR#	+5.0	IO Power Direction. Pull down to request power.
30	IO_PWR_LVL	+3.3	IO Power Level - Low Indicates 100mA Available - High Indicates 1A Available
31	Reserved		Reserved
32	+5V_GPIO	+5.0	5V Input / Output
33	+5V_GPIO		
34	+5V_GPIO		
35	+5V_GPIO		
36	+5V_GPIO		
37	+5V_GPIO		
38	+5V_GPIO		
39	GND	0	System Ground
40	+5V_GPIO	+5.0	5V Input / Output

SPI

The Ocean HDX has the ability to function as a SPI master through the SPI port which comprises the SPI Master Clock, SPI Master MOSI, SPI Master CS and SPI Master MISO pins. To send messages over the SPI port, use the General SPI Input/Output message. The Ocean HDX does not send or receive any SPI data without direction from the host device. Because SPI is a full-duplex transaction, the General SPI Input/Output message both reads and writes at the same time. For instance, a four byte write will return four bytes of dummy read data, and a four byte read requires four bytes of dummy write data:

- MOSI data is established just prior to the rising edge of the SPI clock
- MISO data is sampled just after a falling edge of the SPI clock.

If using SPI as a master, consult the Ocean HDX Firmware and Advanced Communications document for more details. Consult with an Ocean Insight Sales Manager to obtain this document.

NOTE

Spectra cannot be transferred over SPI communications.

I2C

The Ocean HDX has the ability to function as an I2C master through the I2C port, which includes the I2C-SDA (data), and I2C-SCL (clock) pins. To send messages over the I2C port, use the General I2C Write and General I2C Read messages. Note that the Ocean HDX does not send or receive any I2C data without direction from the host system. The I2C lines are pulled up internally.

If using I2C communication, consult *the Ocean HDX Firmware and Advanced Communications* document for more details. Consult with an Ocean Insight Sales Manager to obtain this document.

NOTE

Spectra cannot be transferred over I2C communications.

RS232

RS232 serial port offers full use of Ocean's OBP commands including spectral transfer.

Default settings for the serial port are:

- Baud Rate: 115200
- Data Bits: 8
- Parity: None
- Stop Bits: 1
- Flow Control: None

If using RS232 communication, consult the Ocean HDX Firmware and Advanced Communications document for more details. Consult with an Ocean Insight Sales Manager to obtain this document.

DB15 Connector Cable (FLAME-CBL-DD4P-DB15P)

This cable connects the Ocean HDX to existing Ocean Insight accessories that use a DB-15HD connector. These include most light sources.

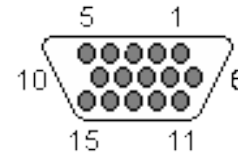

DD4 to DB15 Pin Connections					
15 PIN	DD4	Name	15 PIN	DD4	Name
1	4	Single Strobe	9	8	GPIO 2
2	3	Continuous Strobe	10	1	Ground
3	40	Vusb	11	22	I2C SDA
4	2	External Trigger In	12	21	I2C SCL
5	2	External Trigger In	13	5	Lamp Enable
6	7	GPIO 1	14	NC	Reserved (NC)
7	NC	Reserved (NC)	15	11	GPIO 4
8	2	External Trigger In			

FLAME-CBL-DD4P-PAK50P Cable

This cable is for connecting the Ocean HDX to the Breakout Box or can be connected to a mating connector on a PC board such as in product integration. For the DD4, connect the shield to the connector case, if the shield is included.

DD4P to PAK50P 30-Pin Connections					
PAK50P	DD4	Name	PAK50P	DD4	Name
1	25	RS232Rx	16	11	GPIO4
2	24	RS232Tx	17	4	Single Stroke
3	8	GPIO 2	18	12	GPIO 5
4	40	VUSB	19	16	SPI CLK
5	1	GND	20	3	Continuous Strobe
6	21	12C SCL	21	18	SPI CS
7	2	GPIO 1	22	13	GPIO 6
8	22	12C SDA	23	28	Reserved (do not connect)
9	7	GPIO 1	24	NC	Reserved (NC)
10	2	External Trigger in	25	5	Lamp Enable
11	9	GPIO3	26	14	GPIO 7
12	40	VUSB	27	10	GND
13	17	SPI MOSI	28	NC	Reserved (NC)
14	40	VUSB	29	15	GND
15	19	SPI MISO	30	NC	Reserved (NC)



Breakout Board (FLAME-DD4-BREAKOUT-BOARD)

Ocean Insight also offers the Breakout Board, a passive module that separates the signals to an array of headers, enabling easy access to each pin. The breakout board features a circuit board based on a neutral breadboard pattern that allows custom circuitry to be prototyped on the board itself.

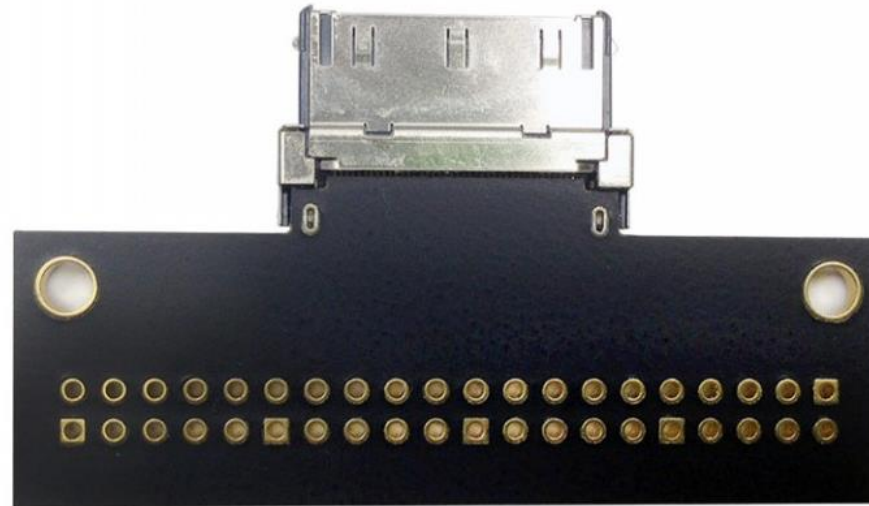

Unlock the Unknown

Ocean Insight exists to end guessing. We equip humanity with technology and data to make precisely informed decisions providing transformational clarity for human advancement in health, safety, and the environment.

Questions?

Chat with us at [OceanInsight.com](https://oceaninsight.com).

info@oceaninsight.com • **US** +1 727-733-2447

EUROPE +31 26-3190500 • **ASIA** +86 21-6295-6600